

# Ultra-Miniature Precision TCXO / VCTCXO Model Cxx Series

# CONNOR WINFIELD



## Description

The Connor-Winfield 2.5x3.2mm Temperature Compensated Crystal Oscillators and Voltage Controlled Temperature Compensated Crystal Oscillators are designed for use in GPS applications requiring tight frequency stability over the -30 to 70°C, -30 to 85°C or -40 to 85°C temperature range. Through the use of Analog Temperature Compensation, this device is capable of holding sub 1-ppm stabilities over the wide temperature range.

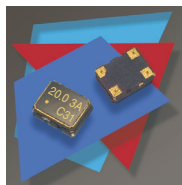

## Features

- 1.8, 2.5, 2.8 or 3.3 Vdc Operation
- Clipped Sinewave Output Logic
- Ultra-Miniature 2.5x3.2mm SMT Package
- Frequency Stabilities Available:
  - ±0.50ppm, ±1.00ppm, ±1.50ppm or ±2.00ppm
- Temperature Ranges Available:
  - -20 to 70°C, -30 to 85°C or -40 to 85°C
- Low Power <2mA
- Low Jitter <1ps RMS
- Tape and Reel Packaging
- RoHS Compliant / Lead Free
- Recommended for new designs

## Pad Connections

1. VCTCXO - Control Voltage (Vc)  
TCXO - N/C
2. Ground
3. Output
4. Supply Voltage (Vcc)

## Applications

GPS Receivers

## Package Layout

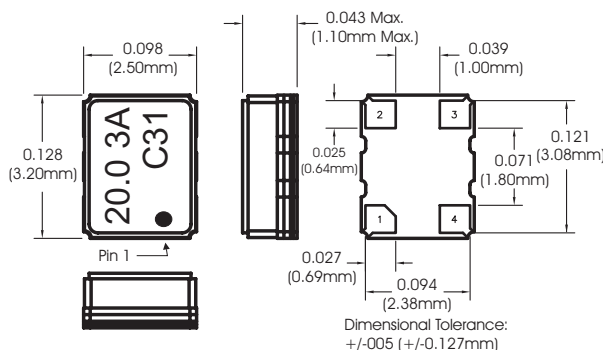

## Suggested Pad Layout

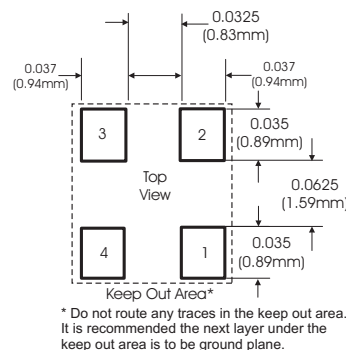

## Ordering Information

<b>C</b>	<b>3</b>	<b>1</b>	<b>-020.0M</b>
<b>Oscillator Type Precision</b>  TCXO VCTCXO 2.5x3.2mm Package	<b>Features</b>  1 = TCXO, 2.5 Vdc, -30 to 85°C 2 = VCTCXO, 2.5 Vdc, -30 to 85°C 3 = TCXO, 3.3Vdc, -30 to 85°C 4 = VCTCXO, 3.3 Vdc, -30 to 85°C 9 = TCXO, 2.5 Vdc, -40 to 85°C 0 = VCTCXO, 2.5 Vdc, -40 to 85°C 7 = TCXO, 3.3Vdc, -40 to 85°C 8 = VCTCXO, 3.3 Vdc, -40 to 85°C A = TCXO, 2.8 Vdc, -30 to 85°C B = VCTCXO, 2.8 Vdc, -30 to 85°C C = TCXO, 2.8 Vdc, -40 to 85°C D = VCTCXO, 2.8 Vdc, -40 to 85°C E = TCXO, 1.8 Vdc, -30 to 85°C F = VCTCXO, 3.3Vdc, -30 to 85°C * G = VCTCXO, 2.8Vdc, -20 to 70°C *frequency stability relative to 25°C	<b>Frequency Stability</b>  1 = ±0.50 ppm 2 = ±1.00 ppm 3 = ±1.50 ppm 4 = ±2.00 ppm	<b>Output Frequency</b>  Frequency Format -xxx.xM Min.* -xxx.xxxxxxM Max*  *Min 1 and Max 6 digits after the decimal point. M = MHz

Example Part Numbers:

C31-020.0M =2.5x3.2mm package, TCXO, 3.3 Vdc -30 to 85°C, ±0.50 ppm, Clipped Sinewave Output with an Output Frequency of 20.0MHz  
 C21-026.0M =2.5x3.2mm package, VCTCXO, 2.5 Vdc -30 to 85°C, ±0.50 ppm, Clipped Sinewave Output with an Output Frequency of 26.0MHz

Please consult the factory for available frequencies.





## Model Specifications

Model Number	C11	CA1	C31	C21	CB1	C41	CE1	Notes
TCXO / VCTCXO	TCXO	TCXO	TCXO	VCTCXO	VCTCXO	VCTCXO	TCXO	
Supply Voltage (Vcc)	2.5 Vdc	2.8 Vdc	3.3 Vdc	2.5 Vdc	2.8 Vdc	3.3 Vdc	1.8 Vdc	
Frequency Stability				±0.50 ppm				1
Operating Temperature Range				-30 to 85°C				
Model Number	C12	CA2	C32	C22	CB2	C42	CE2	Notes
TCXO / VCTCXO	TCXO	TCXO	TCXO	VCTCXO	VCTCXO	VCTCXO	TCXO	
Supply Voltage (Vcc)	2.5 Vdc	2.8 Vdc	3.3 Vdc	2.5 Vdc	2.8 Vdc	3.3 Vdc	1.8 Vdc	
Frequency Stability				±1.00 ppm				1
Operating Temperature Range				-30 to 85°C				
Model Number	C13	CA3	C33	C23	CB3	C43	CE3	Notes
TCXO / VCTCXO	TCXO	TCXO	TCXO	VCTCXO	VCTCXO	VCTCXO	TCXO	
Supply Voltage (Vcc)	2.5 Vdc	2.8 Vdc	3.3 Vdc	2.5 Vdc	2.8 Vdc	3.3 Vdc	1.8 Vdc	
Frequency Stability				±1.50 ppm				1
Operating Temperature Range				-30 to 85°C				
Model Number	C14	CA4	C34	C24	CB4	C44	CE4	Notes
TCXO / VCTCXO	TCXO	TCXO	TCXO	VCTCXO	VCTCXO	VCTCXO	TCXO	
Supply Voltage (Vcc)	2.5 Vdc	2.8 Vdc	3.3 Vdc	2.5 Vdc	2.8 Vdc	3.3 Vdc	1.8 Vdc	
Frequency Stability				±2.00 ppm				1
Operating Temperature Range				-30 to 85°C				
Model Number	C91	CC1	C71	C01	CD1	C81	CF1	Notes
TCXO / VCTCXO	TCXO	TCXO	TCXO	VCTCXO	VCTCXO	VCTCXO	VCTCXO	
Supply Voltage (Vcc)	2.5 Vdc	2.8 Vdc	3.3 Vdc	2.5 Vdc	2.8 Vdc	3.3 Vdc	3.3 Vdc	
Frequency Stability				±0.50 ppm				1
Operating Temperature Range	-40 to 85°C	-40 to 85°C	-40 to 85°C	-40 to 85°C	-40 to 85°C	-40 to 85°C	-30 to 85°C	
Model Number	C92	CC2	C72	C02	CD2	C82		Notes
TCXO / VCTCXO	TCXO	TCXO	TCXO	VCTCXO	VCTCXO	VCTCXO		
Supply Voltage (Vcc)	2.5 Vdc	2.8 Vdc	3.3 Vdc	2.5 Vdc	2.8 Vdc	3.3 Vdc		
Frequency Stability				±1.00 ppm				1
Operating Temperature Range				-40 to 85°C				
Model Number	C93	CC3	C73	C03	CD3	C83		Notes
TCXO / VCTCXO	TCXO	TCXO	TCXO	VCTCXO	VCTCXO	VCTCXO		
Supply Voltage (Vcc)	2.5 Vdc	2.8 Vdc	3.3 Vdc	2.5 Vdc	2.8 Vdc	3.3 Vdc		
Frequency Stability				±1.50 ppm				1
Operating Temperature Range				-40 to 85°C				
Model Number	C94	CC4	C74	C04	CD4	C84		Notes
TCXO / VCTCXO	TCXO	TCXO	TCXO	VCTCXO	VCTCXO	VCTCXO		
Supply Voltage (Vcc)	2.5 Vdc	2.8 Vdc	3.3 Vdc	2.5 Vdc	2.8 Vdc	3.3 Vdc		
Frequency Stability				±2.00 ppm				1
Operating Temperature Range				-40 to 85°C				
Model Number	CG1							Notes
TCXO / VCTCXO				VCTCXO				
Supply Voltage (Vcc)				2.8 Vdc				
Frequency Stability				±0.5 ppm				1
Operating Temperature Range				-20 to 70°C				

## Absolute Maximum Ratings

Parameter	Minimum	Nominal	Maximum	Units	Notes
Storage Temperature	-55	-	125	°C	
Supply Voltage (Vcc)	-0.5	-	6.0	Vdc	
Input Voltage (Vc)	-0.5	-	Vcc+0.5	Vdc	

Absolute Ratings: Stresses beyond those listed under "absolute maximum ratings" may cause permanent damage to the device. These are stress ratings only. The functional operation of the device at those or any other conditions beyond those indicated under "recommended operating conditions" is not implied. Exposure to conditions outside the "recommended operating conditions" for any extended period of time may adversely impact device reliability and result in failures not covered by warranty.

Bulletin	TX211
Page	2 of 4
Revision	15



## Operating Specifications

Parameter	Minimum	Nominal	Maximum	Units	Notes
Center Frequency	10	-	40	MHz	
Frequency Calibration @ 25°C	-1.0	-	1.0	ppm	2
Supply Voltage Variation (Vcc±5%)	-0.025	-	0.025	ppm	
Load Coefficient (±5%)	-0.025	-	0.025	ppm	
Aging per year	-1.0	-	1.0	ppm	
Static Temperature Hysteresis	-0.4	-	0.4	ppm	3
Frequency shift after reflow soldering	-1.0	-	1.0	ppm	
Supply Voltage (Vcc)					
1.8 Vdc Models	1.710	1.800	1.890	Vdc	
2.5 Vdc Models	2.375	2.500	2.625	Vdc	
2.8 Vdc Models	2.660	2.800	2.940	Vdc	
3.3 Vdc Models	3.135	3.300	3.465	Vdc	
Supply Current (Icc)	-	-	2	mA	
Period Jitter	-	3	5	ps rms	
Integrated Phase Jitter (BW=12 Khz to 20 MHz)	-	0.3	1.0	ps rms	
Typical SSB Phase Noise for 26 MHz					
@ 10Hz offset	-	-80	-	dBc/Hz	
@ 100Hz offset	-	-110	-	dBc/Hz	
@ 1KHz offset	-	-130	-	dBc/Hz	
@ 10KHz offset	-	-145	-	dBc/Hz	
@ 100KHz offset	-	-150	-	dBc/Hz	
Start-up Time-	-	-	10	ms	

## Control Voltage Characteristics

Parameter	Minimum	Nominal	Maximum	Units	Notes
Control Voltage (Vc)					
2.5 Vdc Models	0.2	1.2	2.2	V	
2.8 Vdc Models	0.4	1.4	2.4	V	
3.3 Vdc Models	0.5	1.5	2.5	V	
Frequency Pullability @ 25°C	±10	-	-	ppm	4
Control Slope		Positive Slope			
Monotonic Linearity	-	-	±5	%	
Input Impedance	50K	-	-	Ohm	
Modulation Bandwidth (3dB)	10	-	-	KHz	

## Clipped Sinewave Output Characteristics

Parameter	Minimum	Nominal	Maximum	Units	Notes
Load		10pF // 10 KOhm			5, 6
Output Voltage	1.0	-	-	V peak to peak	7

## Package Characteristics

Package	Hermetically sealed ceramic package and metal cover
---------	---

## Environmental Characteristics

Vibration:	Vibration per Mil Std 883E Method 2007.3 Test Condition A
Shock:	Mechanical Shock per Mil Std 883E Method 2002.4 Test Condition B.
Soldering Process:	RoHS compliant lead free. See soldering profile on page 4.

### Notes:

1. Frequency stability vs. change in temperature  $[\pm(F_{max}-F_{min})/(2*F_0)]$ , Vc = nominal control voltage for VCTCXO models. Option "F" frequency stability is measured relative to the frequency measured at 25°C.
2. Initial calibration @ 25°C, Vc = nominal control voltage for VCTCXO models. Specification at the time of shipment after 48 hours of operation.
3. Frequency change after reciprocal temperature ramped over the operating range. Frequency measured before and after @ 25°C.
4. Pull range is referenced to Fo. Pullability will be sufficient to compensate for 20 yrs aging, freq shift after reflow, supply voltage stability, and load sensitivity.
5. Attention: To achieve the frequency stability specified it is required that the circuit connected to this TCXO output must have the equivalent input capacitance that is specified by the nominal load capacitance. Deviations from the nominal load capacitance will have a graduated effect on the stability of approximately 20ppb per pF load difference.
6. Load capacitor, load resistor, coupling capacitor and by pass capacitors are required components to insure proper operation of this TCXO / VCTCXO.
7. Output is DC coupled.

Bulletin	TX211
Page	3 of 4
Revision	15
Date	21 March 2017

## Test Circuit

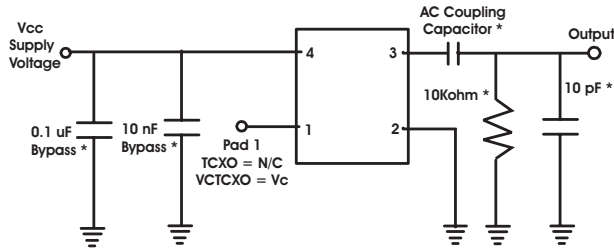

\* Required components to insure proper operation.

## Typical Phase Noise Plot

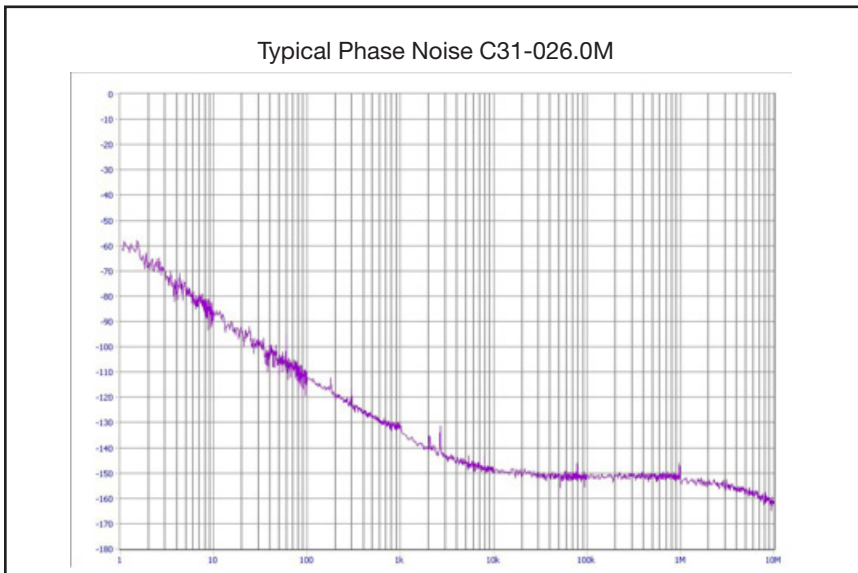

## Tape and Reel Information

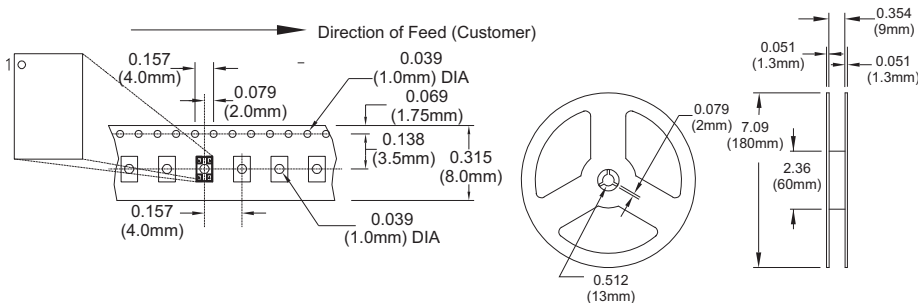

## Output Waveform

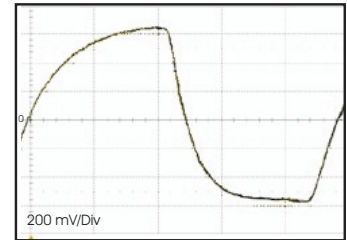

## Solder Profile

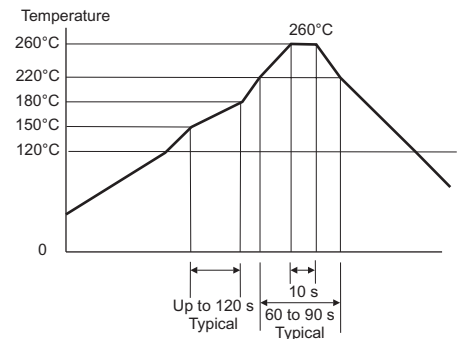

Meets IPC/JEDEC J-STD-020C

## Marking Information

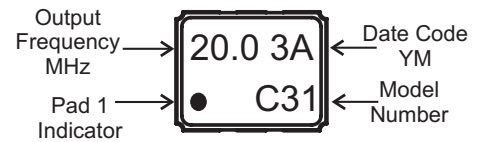

## Date Code Information

LASER: 2 Character Date Code

Year Code	Month Code
3 = 2013	A = January
4 = 2014	B = February
5 = 2015	C = March
6 = 2016	D = April
7 = 2017	E = May
8 = 2018	F = June
9 = 2019	G = July
	H = August
	J = September
	K = October
	M = November
	N = December

Date Code Example: 3J  
3 = 2013, J = September

Bulletin	TX211
Page	4 of 4
Revision	15
Date	21 March 2017